



**Braided Packing**



# Braided Packing

## Introduction

Braided packing is used to provide hermetic conditions during rotary, alternate or helicoidal movement. Its functional or hermetic principle is achieved by the interference provided by external tightening.

Our braided packing comes in spools in a variety of lengths. The weight of these spools depends on their section, length and the material used.

This catalogue contains a selection of the most commonly used materials that can be supplied, depending on the working conditions and applications.

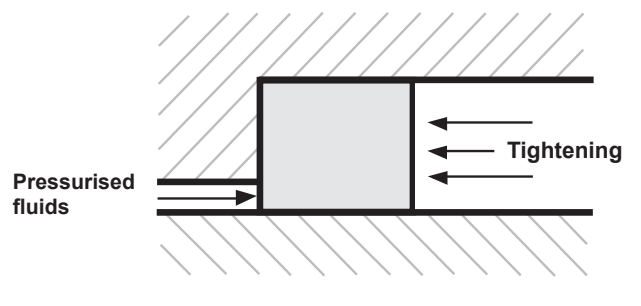

## Selection

The following should be known in order to choose the adequate type of braided packing:

- Fluid (liquid or gas).
- pH.
- Temperature.
- Pressure.
- Type of movement.
- Speed.
- Ø the shaft and its housing.

It is essential to take each of these items into consideration to select the ideal type of packing.

## Surface finishes, Housing

For the braided packing to work properly, it is necessary for it to be used in housings with specific finishes; otherwise, it will wear quickly.

- Centrifuge pump shafts
  - Spindles
  - Sleeves
- } Rt = 1 a 2.5 micra
- Stuffing box Rt = 16 micra (Ø ext.)

Shaft hardness should be 50 Rockwell C, as a minimum.

## Assembly

In order to use the braided packing in applications where it is necessary, cutting and ring conformation should be carried out by hand.

A cutting pattern can be used or the packing can be rolled around the shaft and the rings cut. A 45° bevel cut is recommended.

The rings should be introduced into the stuffing box one by one with the phased cuts placed at 90° to each other and tightened with the clamp of the stuffing box by hand. It should be run with constant leaks for approximately 10 minutes and then tightened until the leak is acceptable (10 to 20 drops per minute).

It is essential that the leak takes the form of drops to ensure that the rings do not overheat.

In packing for pumps, proper tightening can be considered as 0.5 – 1.5 N/cm<sup>2</sup>. Minimum tightening for valves is 5 N/cm<sup>2</sup>.

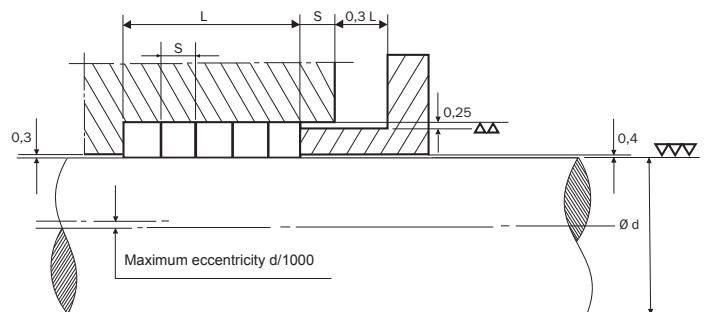
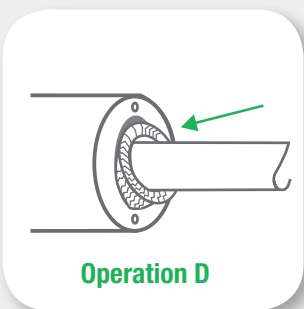
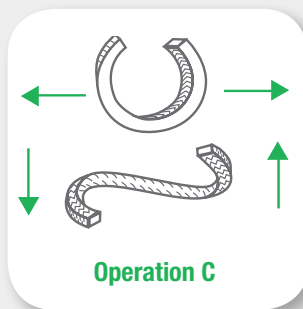

Housing tolerances (mm) and finish tolerances.

## Graphite base packing

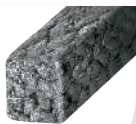

### CL20000



Braided packing with carbon fibres and a lubricant finish to improve the packing friction properties.

	P bar	V m/s	pH	T °C
	200	1		-100/+650*
	20	2	0 ÷ 14	
	40	25		

\* With weak oxidants and hot air.

#### APPLICATIONS

Pumps and agitators with high temperatures. Steam facilities Very good chemical resistance and high thermal conductivity.

## Expanded mineral graphite base

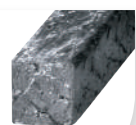

### GR 3030



Braided self-lubricating packing with high purity expanded graphite fibers and corrosion inhibitors.

	P bar	V m/s	pH	T °C
	-	-		-100/+650
	-	-	0 ÷ 14	
	80	25		

#### APPLICATIONS

Applications in general, where there is high temperature. Resistant to marine environments.

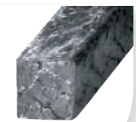

### GR 3080



Packing made from expanded graphite fibres reinforced with metal filaments and corrosion inhibitors.

	P bar	V m/s	pH	T °C
	300	1		-100/ +650
	--	--	0 ÷ 14	
	--	--		

#### APPLICATIONS

For valves that must operate at high pressures and temperatures. Excellent resistance in marine environments and in industrial applications in general.

## Synthetic fibre base for general

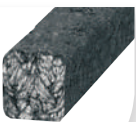

### FA 2480



Diagonally braided packing with acrylic fibre lubricated with PTFE and graphite lubricants

	P bar	V m/s	pH	T °C
	60	1		-50 / +250
	40	3	4 ÷ 10	
	20	10		

#### APPLICATIONS

Centrifugal pumps, alternatives, valves, agitators and unsafe applications.



## FA 2490

Diagonally braided packing with acrylic fibre lubricated with PTFE .

P bar	V m/s	pH	T°C
100	1,5	2 ÷ 12	-100 / +250
80	2		
50	15		



### APPLICATIONS

Centrifugal pumps, alternatives, valves, agitators and unsafe applications.



## FR 2470

Braided packing with ramie threads impregnated with lubricating PTFE.

P bar	V m/s	pH	T°C
60	1	4 ÷ 10	-50 / +250
40	3		
20	10		



### APPLICATIONS

Centrifugal pumps, alternatives, valves, agitators and unsafe applications.

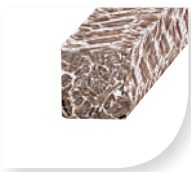

## FK 6200

Braided diagonal gasket with phenolic fibers, lubricated with graphite dispersion and lubricants.

P bar	V m/s	pH	T°C
-	-	1 ÷ 12	-50 / +250
250	5		
100	20		



### APPLICATIONS

Centrifugal pumps, agitators and unsafe applications. Good chemical resistance and good mechanical resistance. Good thermal conductivity

## Base high performance synthetic fibers



## KT 30410

Diagonal braided packing with pure PTFE expanded and reinforced at the corners with aramid fibers.

P bar	V m/s	pH	T°C
500	3	3 ÷ 12	-100 / +280
300	4		
--	10		



### APPLICATIONS

Centrifugal pumps, alternatives, agitators and autoclaves. Recommended for abrasive fluids. Good chemical resistance Good mechanical resistance



## KT 30810

Braided packing diagonally, in the center with expanded PTFE, graphite and GFO® fibers and in the corners reinforced with aramid fibers.

	P bar	V m/s	pH	T°C
	350	2		-100 / +280
	250	4	3 ÷ 12	
	70	25		

### APPLICATIONS

Alternative pumps, agitators. Recommended for abrasive fluids. Good chemical resistance, thermal conductivity. Good mechanical resistance Good performance in applications with high pressures and speeds.



## KT 30820

Diagonal braided packing, in the center with expanded PTFE with high strength fibers. Reinforced in the corners with aramid thread. Compatible with KT 30810.

	P bar	V m/s	pH	T°C
	350	2		-100 / +280
	250	4	3 ÷ 12	
	70	25		

### APPLICATIONS

Alternative pumps, agitators. Recommended for abrasive fluids. Good chemical resistance, thermal conductivity. Good mechanical resistance Good performance in applications with high pressures and speeds.



## KV 30010

Braided packing with aramid fiber yarns, lubricated with PTFE and lubricants.

	P bar	V m/s	pH	T°C
	250	1,5		-100 / +280
	200	10	3 ÷ 12	
	80	25		

### APPLICATIONS

Centrifugal pumps, alternatives, valves, agitators and autoclaves. Recommended for abrasive fluids and low speed. Excellent mechanical resistance The shafts have to be prepared for wear.



## HA 30000

Braided packing with para-aramid fibers with PTFE dispersion and lubricants.

	P bar	V m/s	pH	T°C
	--	--		-100 / +250
	300	8	2 ÷ 12	
	50	30		

### APPLICATIONS

Centrifugal pumps, agitators and applications with abrasive products and high speeds. Good mechanical resistance



## TG 4360

Packing manufactured with continuous aramid fiber is hardly flammable and thermostable. Each fiber is impregnated with PTFE dispersion and silicone-free inert lubricants.

	P bar	V m/s	pH	T °C
	--	--		-100 / +280
	250	3	0 ÷ 14	
	50	30		

### APPLICATIONS

Centrifugal pumps, alternatives, agitators. It allows to be used for multiple applications, simplifying the use of different references. Good chemical resistance and thermal conductivity. Indicated in high speed applications.



## TG 4370

Diagonally braided expanded PTFE packing impregnated with graphite.

	P bar	V m/s	pH	T °C
	300	1,5		-100 / +280
	200	2	0 ÷ 14	
	50	25		

### APPLICATIONS

Centrifugal pumps, alternating pumps and agitators. Can be used in multiple applications, to simplify the use of different product references. Good chemical resistance and thermal conductivity. Indicated in high speed applications.



## TS 4050

Diaphragm braided packing of pure expanded PTFE, without lubricating.

	P bar	V m/s	pH	T °C
	500	1		-100 / +280
	150	3	0 ÷ 14	
	--	--		

### APPLICATIONS

Valves, mixers. Very good chemical and mechanical resistance.



## TL 4050

Diagonal braided packing of expanded pure PTFE, impregnated with lubricants and dispersion of PTFE.

	P bar	V m/s	pH	T °C
	20	1		-100 / +280
	100	2	0 ÷ 14	
	50	8		

### APPLICATIONS

Centrifugal pumps, alternatives and valves. Very good chemical and mechanical resistance. Chemical and pharmaceutical industry.

## Base fiberglass



### HV 9100

Diagonally braided packing with an "E" fiberglass base impregnated with PTFE and graphite.



P bar	V m/s	pH	T°C
250	3	3 ÷ 12	-550

#### APPLICATIONS

For use in hatches, inspection chambers and in the presence of vapours, gases, oils, acids and alkaline substances.



### HV 9200

Braided packing made from fiberglass impregnated with PTFE dispersion.



P bar	V m/s	pH	T°C
250	4	2 ÷ 12	-260

#### APPLICATIONS

For general use in the presence of water, vapour, oil, solvents and chemicals.

## Accessories

We have tools to extract and remove the packing residues of the press-tops.

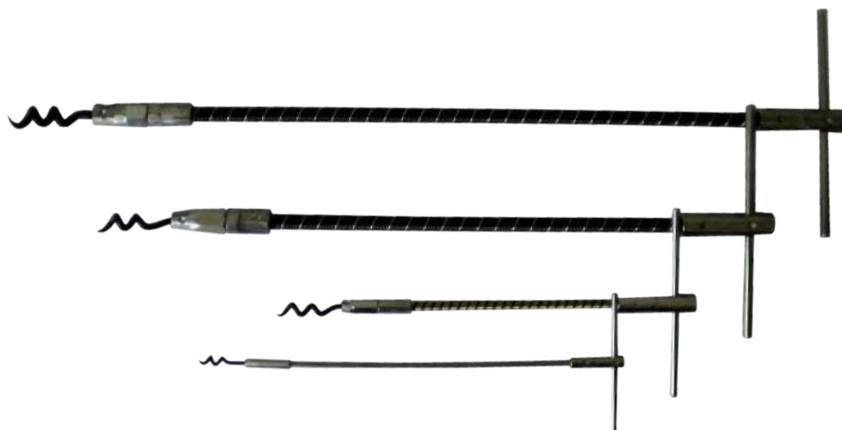

### Extractors

Flexible tools with corkscrew in the tip that have the purpose of extracting and removing the rests of estopada from the press-tops of pumps and valves.

- F1. Length 190 mm. Braid sections > 4x 4. Replacement tip C1.
- F2. Length 280 mm. Braid sections > 8x 8. Replacement tip C2.
- F3. Length 370 mm. Braid sections > 12x12. Replacement tip C3.
- F4. Length 482 mm. Braid sections > 16x16. Without replacement, fixed tip.
- Cutting machines. Machines to cut packings at 45° or straight cut.
- Guillotine machine.
- Machine with knife.

**Lidering S.A.U.**

España  
Cornellà de Llob.  
Headquarters  
International Sales  
+34 93 480 44 10  
Domestic Sales  
93 480 44 30  
Reus  
Production  
93 480 44 30



**Lidering S.A.R.L.**

France  
+33 472 67 02 74

**Lidering GmbH**

Deutschland  
0211 52808563

**S.A. Lidering N.V.**

Belgique-België  
+34 93 480 44 10

**Lidering Mechanical Seals, S.A.**

Panamá  
+507 3971572

[www.lidering.com](http://www.lidering.com)  
[infoweb@lidering.com](mailto:infoweb@lidering.com)

